

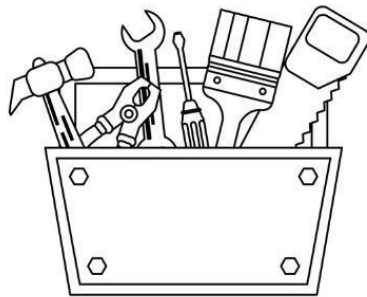

SUNNY GROUP LED SHAVING CABINET

Installation Instruction



IMPORTANT

It is the responsibility of the installer to make any adjustments to doors/ drawers after installation if required. There may have been some movement in transportation and installation which causes doors/ drawers to become unaligned.

Prior to installation it is important to unpackage & inspect your products to ensure no damage has occurred in transit and that the product IS CORRECT. If damages have occurred, or a visible defect exists, do not proceed with installation and contact supplier IMMEDIATELY.

NO CLAIMS ARE ACCEPTED IF DAMAGES/DEFECTS ARE BEING RECOGNIZED AFTER INSTALLATION.

INSTALLATION CHECKLIST

1 Check Products for Any Damages

Prior to installation it is important to unpackage & inspect your products to ensure no damage has occurred in transit and that the product IS CORRECT. If damages has occurred, or a visible defect exists, do not proceed with installation and contact supplier IMMEDIATELY.

No claims for damages/defects will be recognized after installation.

2 Check Support Beam

Wall hung furniture & basins require fixing to a support beam fitted between the studs to give a solid wall backing to attach the vanity to.

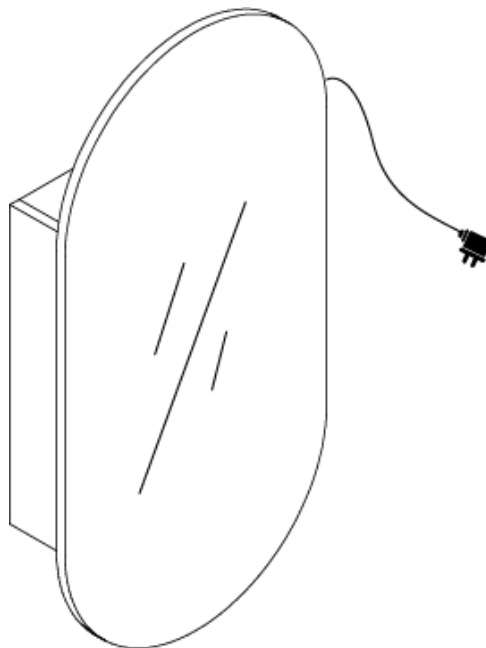

3 Check Your Wall is Flat and Plumb

Before installing, check that your wall is flat and plumb. If not, the cabinet will need to be packed out so that sits level, otherwise the cabinet may twist, causing doors to fall out of alignment and not function properly.



INSTALLATION INSTRUCTION

Required Tools

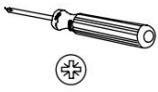

Screwdriver



Tape measure



Pencil



Silicone



Electric drill



Drill bit(Ø8)



Soft Hammer

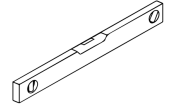

Spirit lever

Supplied Spare Part



(Ø4.2x80mm)



(Ø8x75mm)

Step 1

1

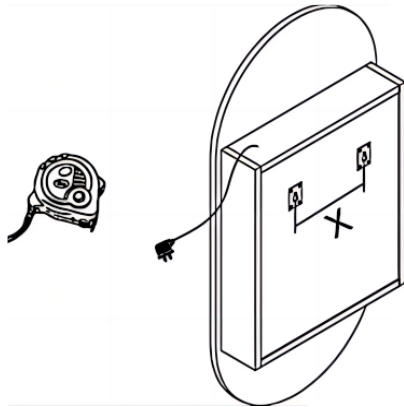

Lay the mirrored cabinet flat and measure the distance between the two mounting holes.

Step 2

2

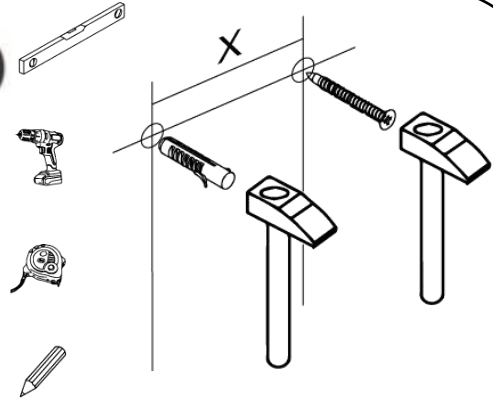

Make marks on the wall with a pencil and ensure they are on the same level before drilling guide holes. Insert the expanding rubber plugs into the holes first, and then drive in the long screws.

Step 3

3

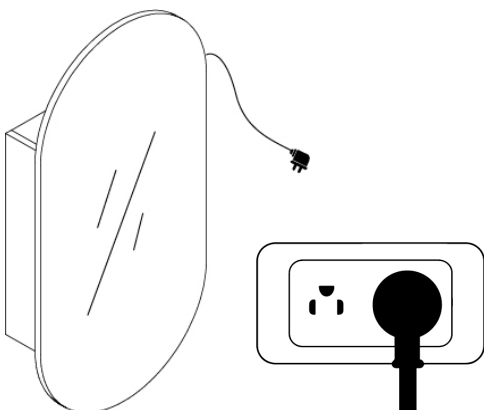

Align the mounting holes on the back panel of the mirrored cabinet with the screws installed on the wall and hang it up.

Note: Please ensure that both screws are properly inserted into the mounting holes.

CARE and MAINTENANCE

Sunny Group products are manufactured from materials that are greatly adapted to bathroom. However, no abrasive cleaners or wax-based creams are used on any gloss cabinets as this can result in a build-up of deposits/scratches that will detract from the appearance. Sufficient ventilation is required to avoid excessive moisture.

The best way will be simply wipe over with a clean and soft cloth. Any excessive moisture or water spillage will always be taken into care.

For cabinets

- 1** To remove scratches, marks, etc. on two pack polyurethane, rub gently with car cutting compound, car polish or household brass/silver cleaner used for car re-treatment, followed by buffing with a car polish and a clean, soft cloth.
- 2** Sunny Group cabinets used in construction are moisture-resistant, but not water-proof.
- 3** All cabinets should be installed against tiles, instead of in the tiles. Cabinets should be at least 300mm away from bathtubs or showers to avoid water damage.

Conditions

- 1** Installation is made by a **LICENSED** tradesman.
- 2** Failure derives from a fault in the quality of the product.
- 3** Proof of purchase should be provided when making a claim.
- 4** The product should be installed properly.
- 5** All cabinets are engineered for moisture proof.
- 6** This warranty does not cover scratching or normal wear and tear, as these are not manufacturing faults.

To fullest extent under the law, SUNNY GROUP (VIC) PTY LTD is not liable for damage to any person or property and any indirect consequence or other loss, SUNNY GROUP (VIC) PTY LTD liability does not include the cost of installation or removal of any product and no warranty will be supplied if damage occurs during or after INSTALLATION or a damaged or incorrect part has been installed. The warranty does not cover the issue by improper installation, accidents, misuse, abuse and negligence, installation or part installation by the purchaser or any person other than a LICENCED TRADESPERSON. Must avoid contact with hard sharp objects due to the nature of stainless steel material it can be SCRATCHED with normal day to day use this is not covered by warranty. Don't use Harsh cleaning products that contain chlorides and halides eg (Bromine, Iodine and Fluorine). Don't use Hydrochloric Acid (HC) for cleaning this will lead to pitting and stress corrosion cracking (SCC).